



24V ROPE TRACK



DC
24V

D
ULTRA THIN LIGHT SERIES



ULTRA THIN LIGHT SERIES



ROPE TRACK

In the lighting design, based on the use of traditional lines and tracks, get rid of the constraints in space design, expand the thinking of lighting designers to achieve unrestrained lighting display. This is not only the effect of the lighting display, but also the brush of the lighting designer for the space lighting design, which is a set of flexible artworks!



ROPE TRACK

Points, lines and surfaces that shuttle freely in space lighting design.



ROPE TRACK

According to the different needs of space lighting design, flexible application of fulcrum and lamps to achieve the ideal lighting enjoyment.



LIGHT

ULTRA THIN LINEAR TRACK
ROPE TRACK



ROPE TRACK

It Take space lighting to another level

In the process of lighting design, braided track design provides a powerful role for imagining fantasies. Combine multiple luminaire lighting to place lighting effects more precisely where they are needed, creating more visual layers in any space.

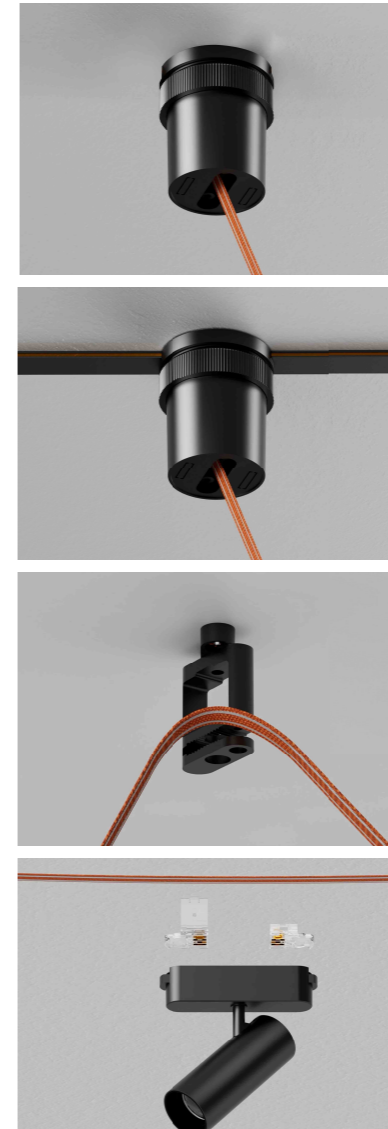

ROPE TRACK

There are exclusive fittings that combine to make straight track lamps available for rope track

An extension of the braided track can be obtained by placing a fulcrum on each position where the track is pulled.

The fulcrum has a variety of installation methods, can be installed on the ceiling, can also be installed on the aluminum rail, can be used as a power fulcrum, that is, can be used as an expansion fulcrum, not subject to environmental restrictions.

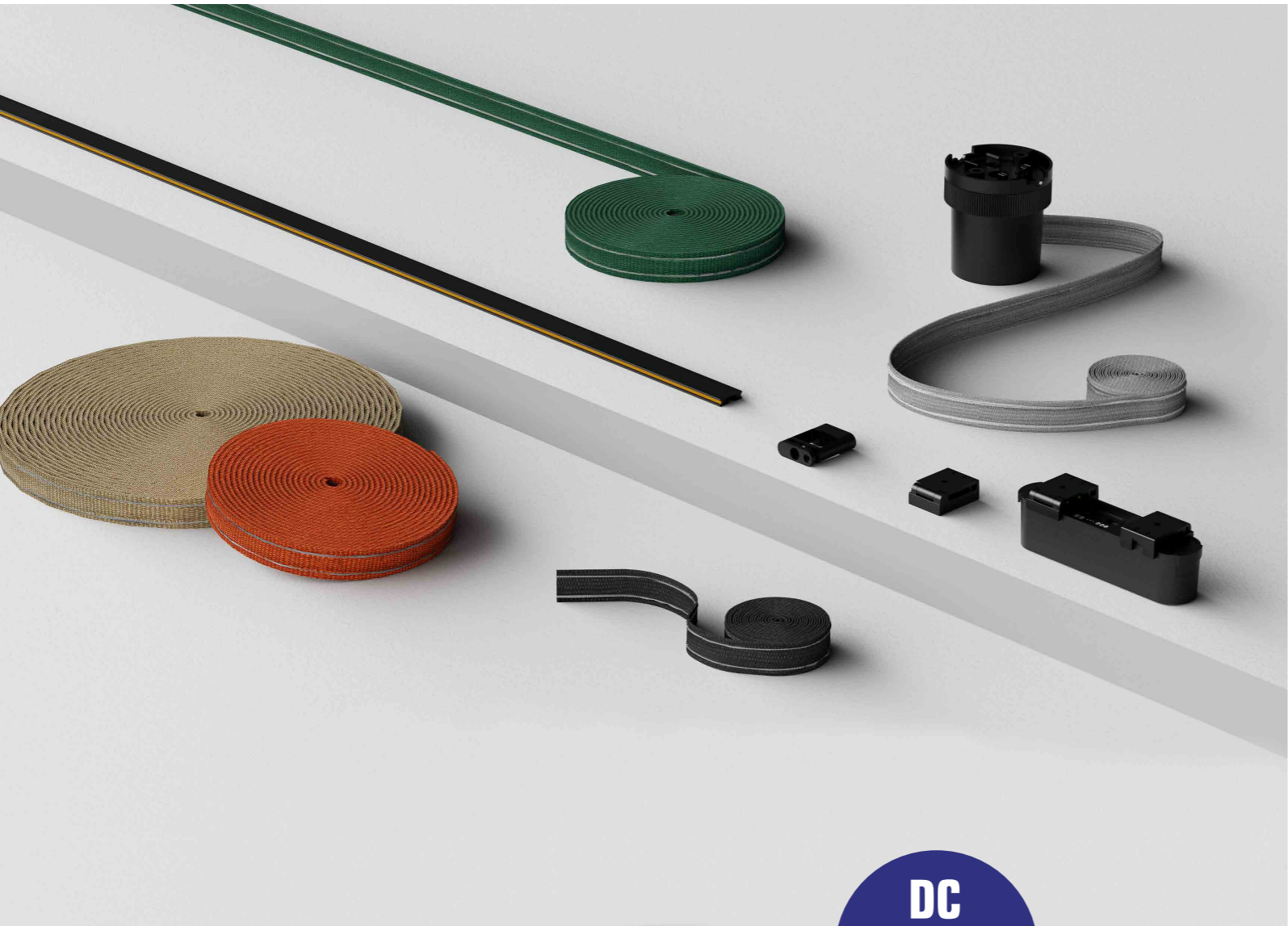

24V ROPE TRACK

DC
24V

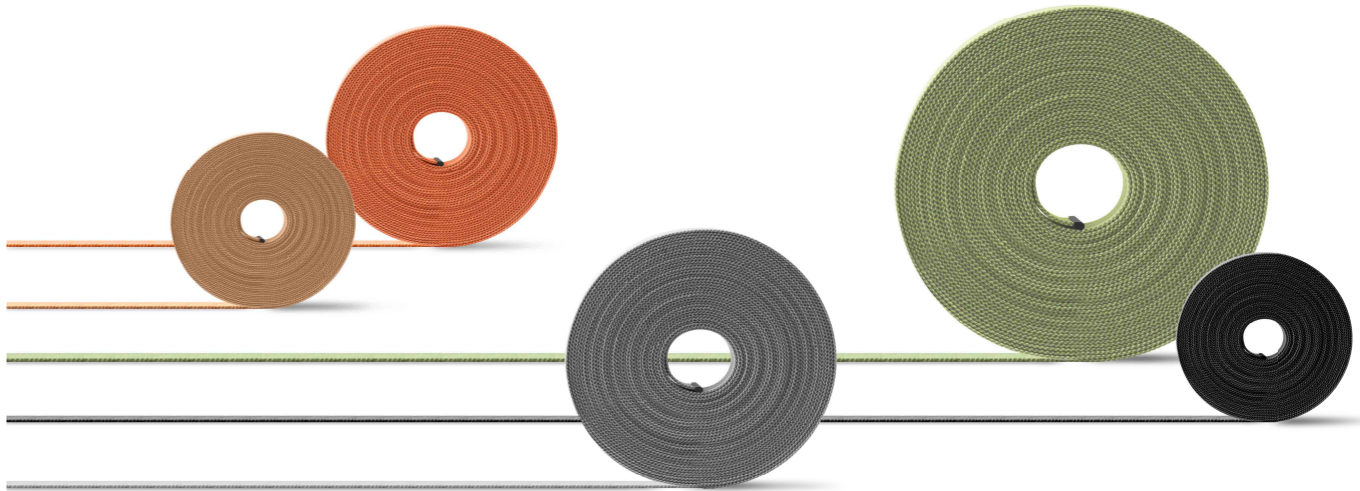

24V ROPE TRACK

- Black
- Gray
- Green
- Khaki
- Orange

Rope track available in a variety of colors, ideal for matching

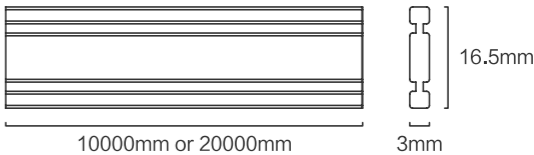

ITEM NO: LI-PD-10M
 Product Size: 10000x16.5x3mm

ITEM NO: LI-PD-20M
 Product Size: 20000x16.5x3mm

Watt: 200W(Max)
 Voltage: DC 24V
 Material: Hessian+ Copper

ACCESSORIES USING ROPE TRACK



ITEM NO: LI-PDYT
Name: Large fixed nodes

Feature

1. Track conductive conversion function
2. Braided track steering installation
3. Suitable for ceiling, wall and ground installation

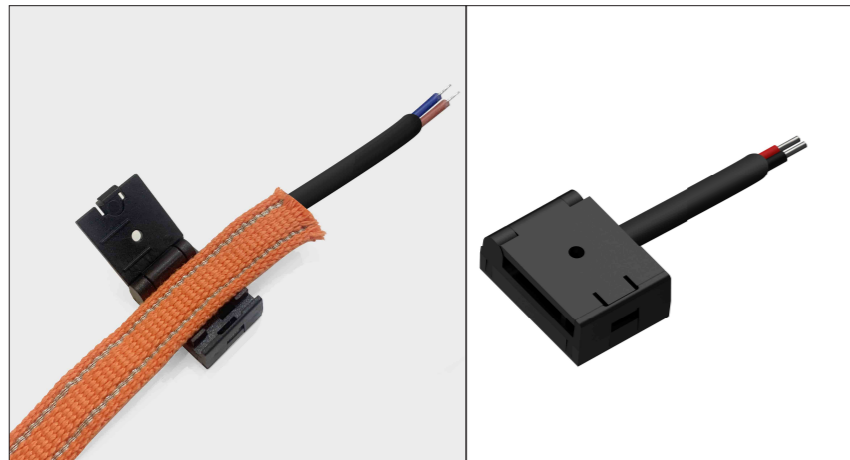

ITEM NO: LI-PDSR
Name: Braid track input module

Feature

Braided track power supply module



ITEM NO: LI-PDDK
Name: Linker

Feature

The luminaire is connected to a braided track

ACCESSORIES USING ROPE TRACK



ITEM NO: LI-PDGK
Name: Small fixed nodes

Feature

Braided track holding adjuster bracket



ITEM NO: LI-DX
Name: Sling bag

Feature

The woven track can be used for suspension while shaping



ULTRA THIN LIGHT SERIES

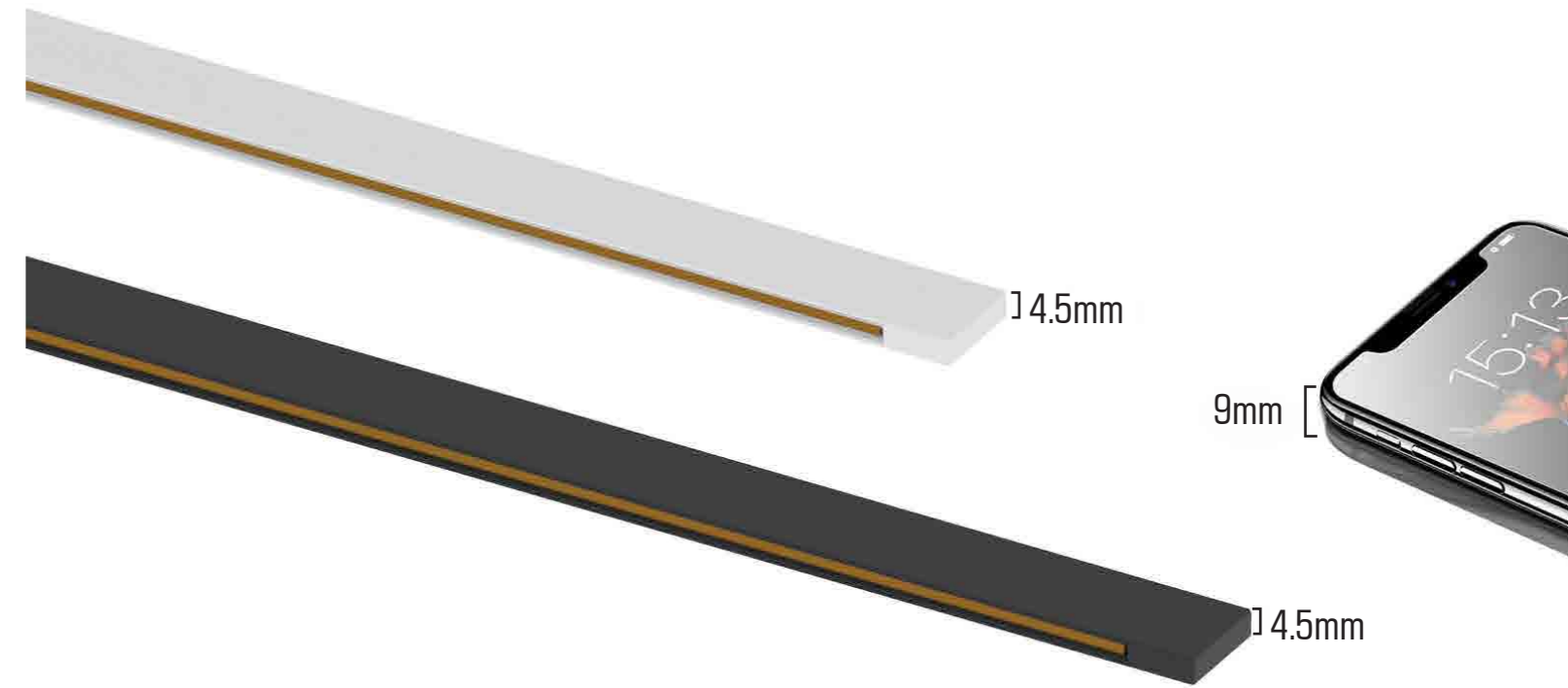

24V

Complete installation accessories, convenient installation according to space design

ultra-thin new series linear track system has developed a variety of fittings,
cable storage boxes and other accessories, to adapt to more decoration schemes installation.



Straight connect
module



L connect
module



T connect
module



Cross connect
module



In&Out connect
module



Cable
Box

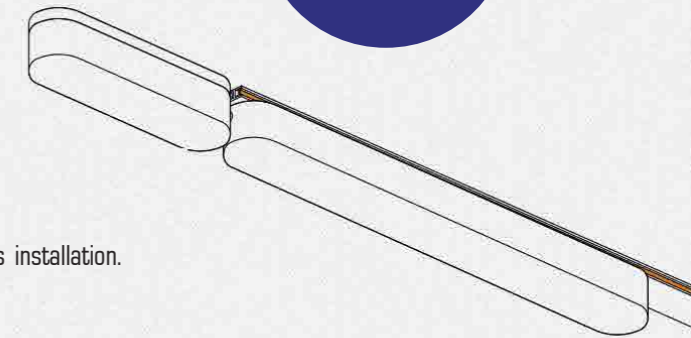

ULTRA THIN LIGHT SERIES



24V

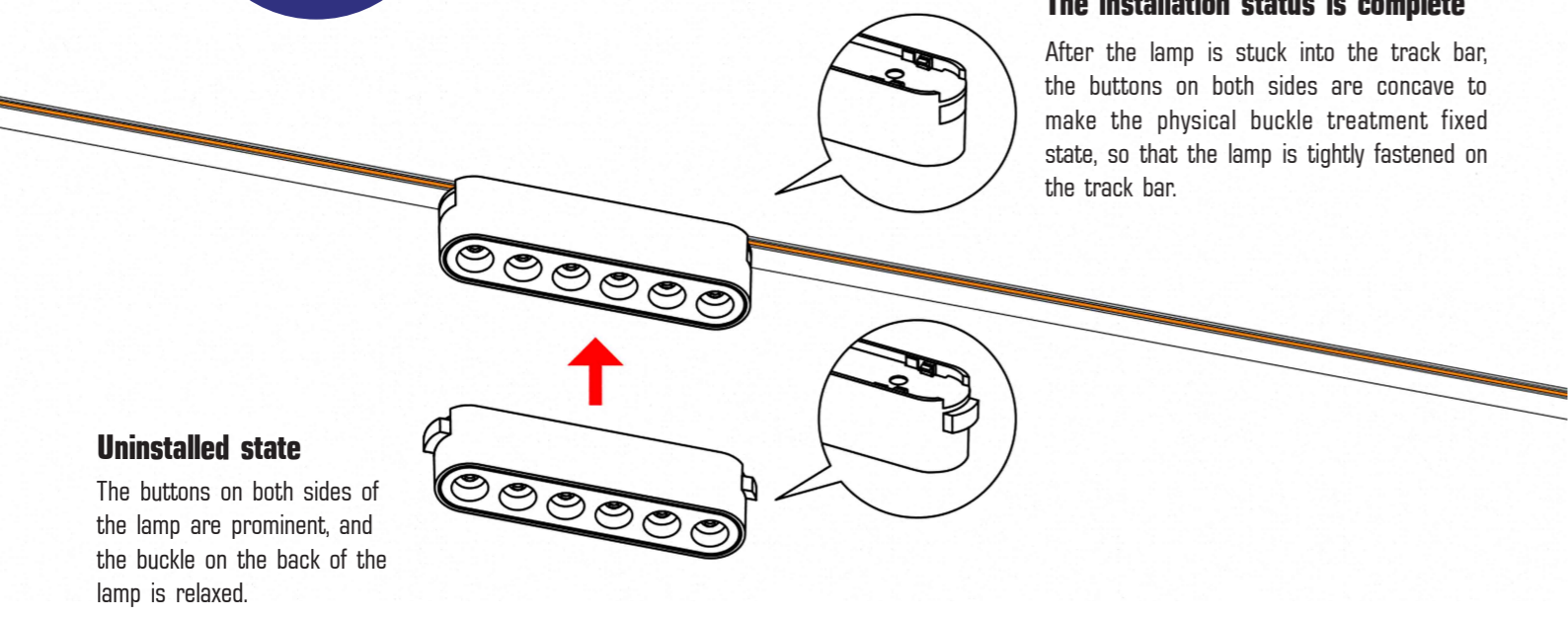

Uninstalled state
The buttons on both sides of the lamp are prominent, and the buckle on the back of the lamp is relaxed.

The installation status is complete

After the lamp is stuck into the track bar, the buttons on both sides are concave to make the physical buckle treatment fixed state, so that the lamp is tightly fastened on the track bar.

The lamp has two usage modes

24V

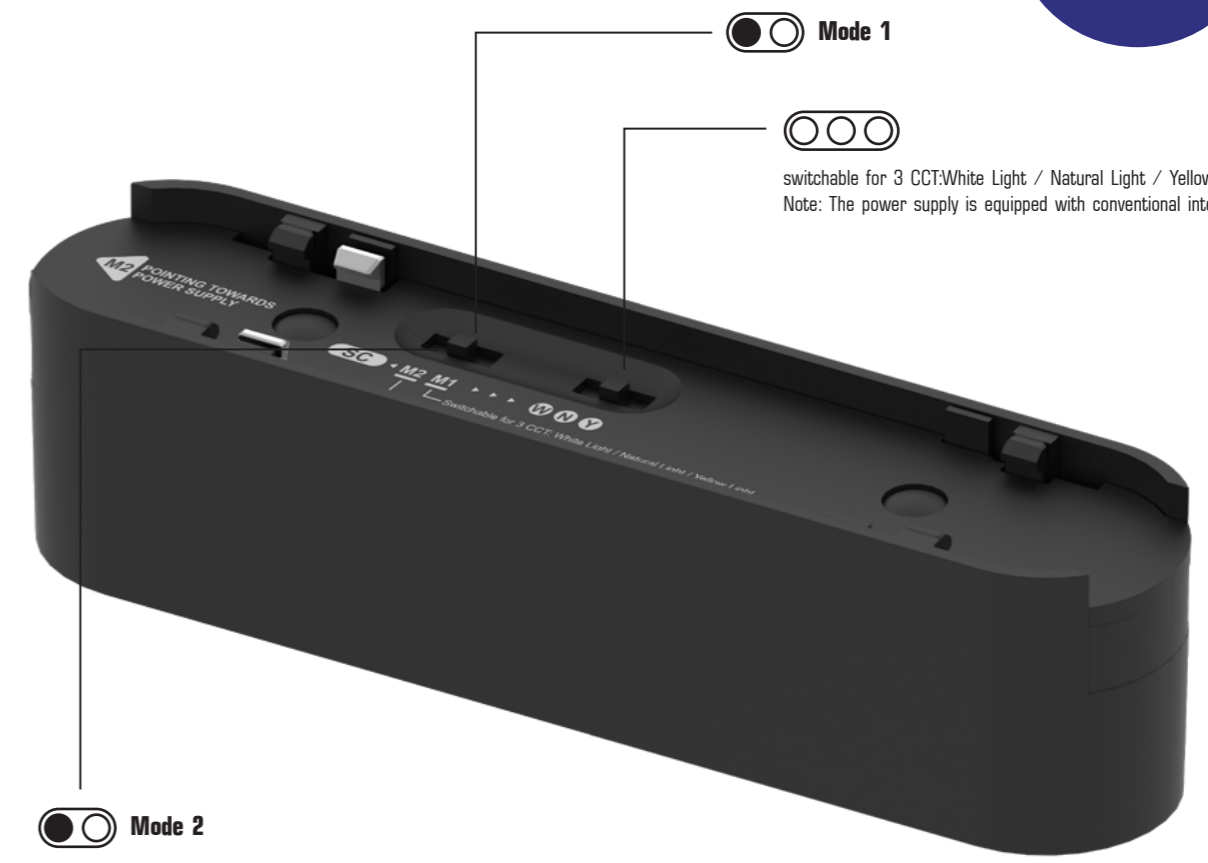

switchable for 3 CCT: White Light / Natural Light / Yellow Light
Note: The power supply is equipped with conventional integrated power supply.

Mode 2

Smart control dimming and color adjustment: 2.4G / TUYA / ZigBee / MiJia
Note: need to match with the corresponding dimming color system integrated power supply, integrated power supply.

2.4 GHz 2.4G SYSTEM **tuya** ZigBee **miJia**

The lamp has two usage modes

Mode 1:
switchable for 3 CCT: White Light / Natural Light / Yellow Light

Mode	CCT
 Mode 1 Mode 2	 Yellow Light Natural Light White Light

Mode 2:
Smart control dimming and color adjustment: 2.4G / TUYA / ZigBee / MiJia

Mode	System with selectable power supply
 Mode 1 Mode 2	

ULTRA THIN LIGHT SERIES

Grille light 6 in 1

Flood light

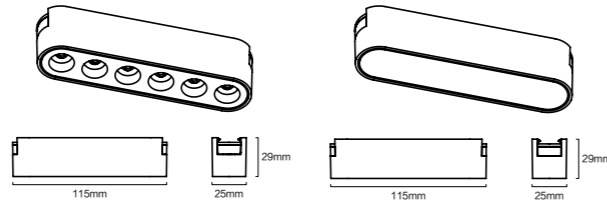
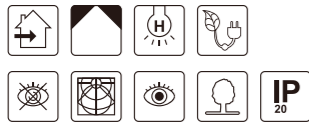
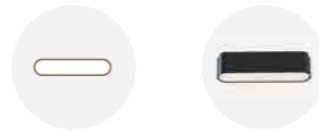
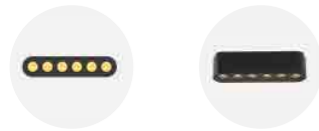

Application:
hotels, office, conference room, museums, restaurants, etc.

Option:
Black/White

ITEM NO	Material	WATTAGE (w)	Voltage (V)	Angle (°)	CRI	Flicker Free	Optic	SIZE(MM) AXBXH
LI-6T	Aluminum+PC	6W	DC 24V	24°	>90	<3%	Lens	115X25X29mm

ITEM NO	Material	WATTAGE (w)	Voltage (V)	Angle (°)	CRI	Flicker Free	Optic	SIZE(MM) AXBXH
LI-6F	Aluminum+PC	6W	DC 24V	110°	>90	<3%	PC Diffusion	115X25X29mm

Grille light 12 in 1

Flood light

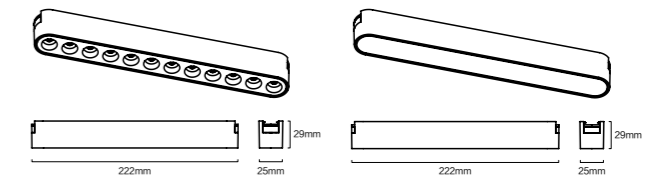
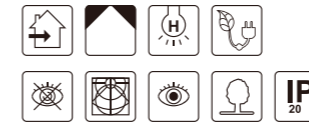
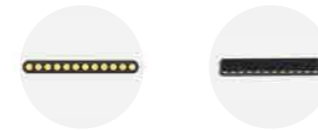

Application:
hotels, office, conference room, museums, restaurants, etc.

Option:
Black/White

ITEM NO	Material	WATTAGE (w)	Voltage (V)	Angle (°)	CRI	Flicker Free	Optic	SIZE(MM) AXBXH
LI-12T	Aluminum+PC	12W	DC 24V	24°	>90	<3%	Lens	222X25X29mm

ITEM NO	Material	WATTAGE (w)	Voltage (V)	Angle (°)	CRI	Flicker Free	Optic	SIZE(MM) AXBXH
LI-12F	Aluminum+PC	12W	DC 24V	110°	>90	<3%	PC Diffusion	222X25X29mm



ULTRA THIN LIGHT SERIES

Grille light 18 in 1

Flood light

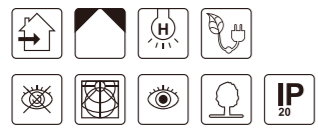
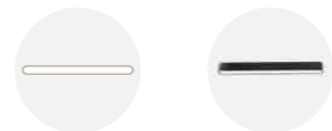

Application:
hotels, office, conference room, museums, restaurants, etc.

Option:
Black/White

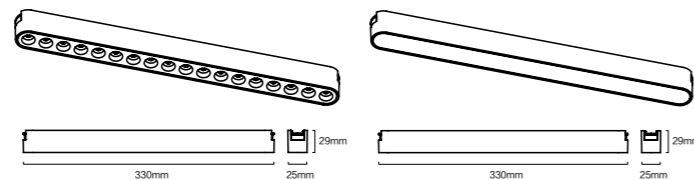

ITEM NO	Material	WATTAGE (w)	Voltage (V)	Angle (°)	CRI	Flicker Free	Optic	SIZE(MM) AXBXH
LI-18T	Aluminum+PC	18W	DC 24V	24°	>90	<3%	Lens	330X25X29mm

ITEM NO	Material	WATTAGE (w)	Voltage (V)	Angle (°)	CRI	Flicker Free	Optic	SIZE(MM) AXBXH
LI-18F	Aluminum+PC	18W	DC 24V	110°	>90	<3%	PC Diffusion	330X25X29mm

Solar eclipse Wall lamp

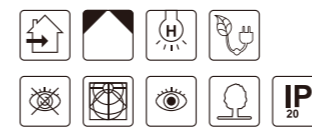
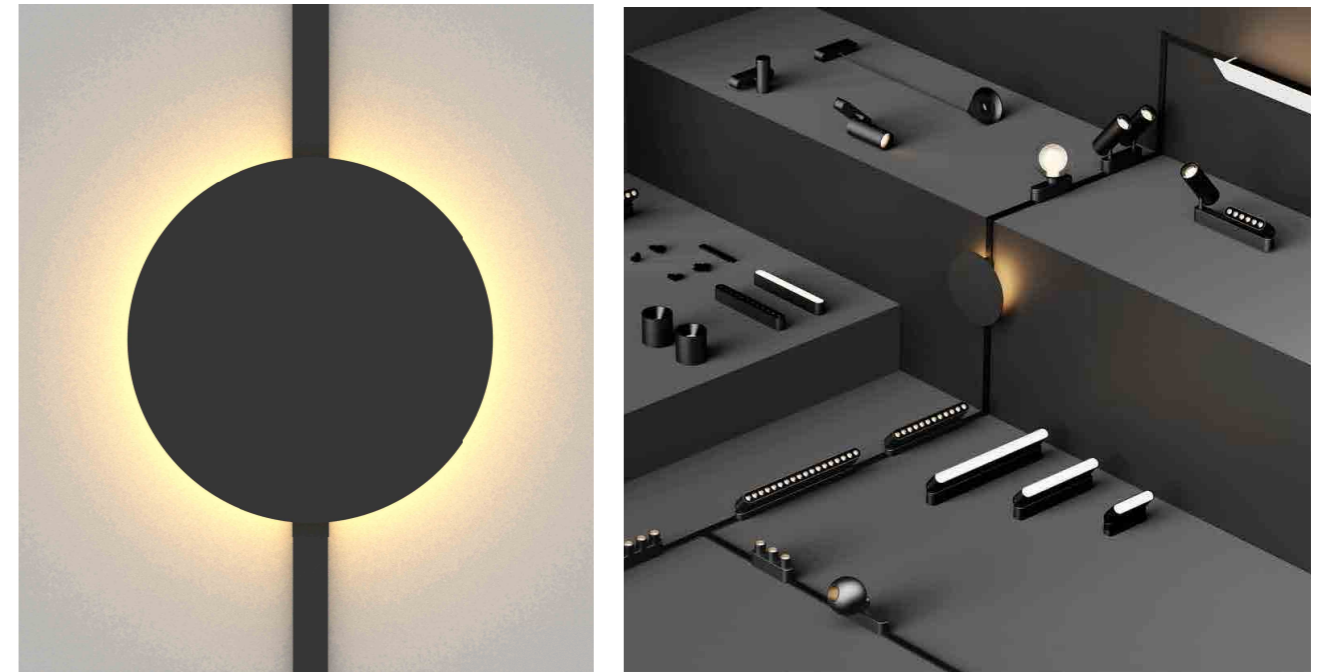

Application:
hotels, office, conference room, museums, restaurants, etc.

Option:
Black/White

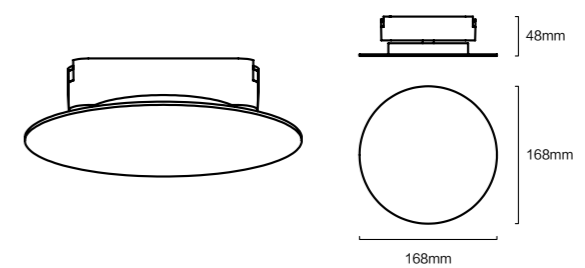

ITEM NO	Material	WATTAGE (w)	Voltage (V)	Angle (°)	CRI	Flicker Free	Optic	SIZE(MM) CXH
LI-YSBD	Aluminum+PC	6W	DC 24V	80°	>90	<3%	PMMA	Φ 168X48mm

ULTRA THIN LIGHT SERIES

Adjustable Wall lamp

Adjustable Wall lamp

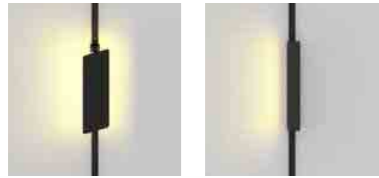
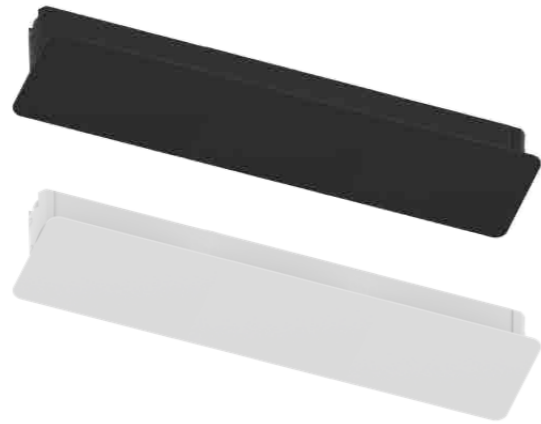

Application:
hotels, office, conference room, museums, restaurants, etc.

Option:
Black/White

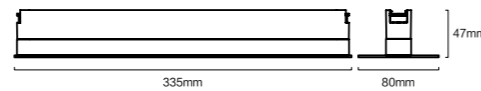
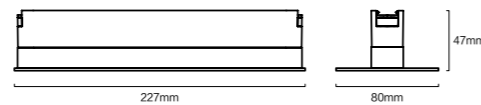

ITEM NO	Material	WATTAGE (w)	Voltage (V)	Angle (°)	CRI	Flicker Free	Optic	SIZE(MM) AXBXH
L-DP-12F	Aluminum+PC	12W	DC 24V	120°	>90	<3%	PC Diffusion	227X80X47mm

ITEM NO	Material	WATTAGE (w)	Voltage (V)	Angle (°)	CRI	Flicker Free	Optic	SIZE(MM) AXBXH
L-DP-18F	Aluminum+PC	18W	DC 24V	120°	>90	<3%	PC Diffusion	335X80X47mm

Track Lights

Track Lights 2 in 1



Application:
hotels, office, conference room, museums, restaurants, etc.

Option:
Black/White

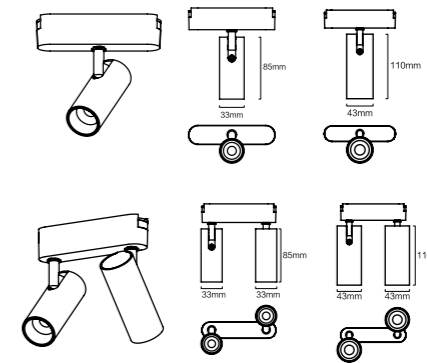

ITEM NO	Material	WATTAGE (w)	Voltage (V)	Angle (°)	CRI	Flicker Free	Optic	SIZE(MM) CXH
L-L33	Aluminum+PC	6W	DC 24V	24°	>90	<3%	Lens	Φ 33X85mm
L-L33*2	Aluminum+PC	6Wx2	DC 24V	24°	>90	<3%	Lens	Φ 33X85mm

ITEM NO	Material	WATTAGE (w)	Voltage (V)	Angle (°)	CRI	Flicker Free	Optic	SIZE(MM) CXH
L-L43	Aluminum+PC	12W	DC 24V	24°	>90	<3%	Lens	Φ 43X110mm
L-L43*2	Aluminum+PC	12Wx2	DC 24V	24°	>90	<3%	Lens	Φ 43X110mm

ULTRA THIN LIGHT SERIES

Frosted Glass Ball Ball shaped track light

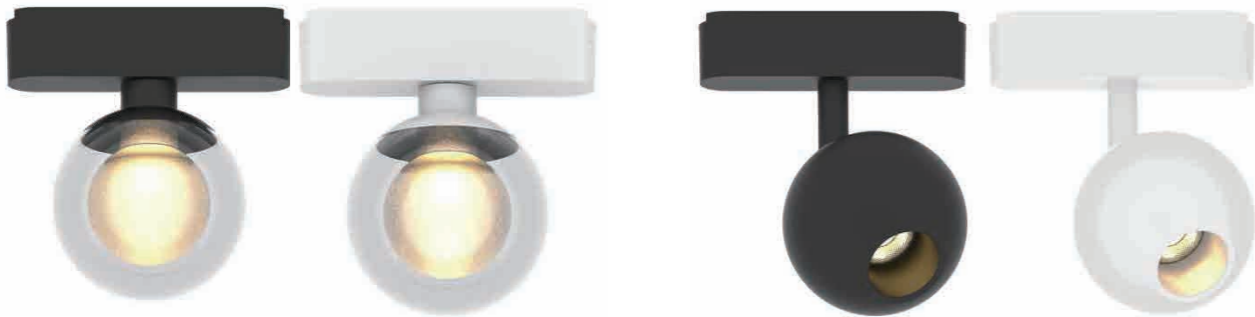

Application:
hotels, office, conference room, museums, restaurants, etc.

Option:
Black/White

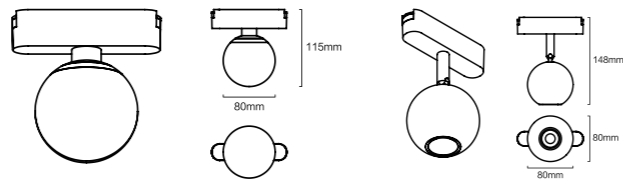

ITEM NO	Material	WATTAGE (w)	Voltage (V)	Angle (°)	CRI	Flicker Free	Optic	SIZE(MM) CXH
LI-B80	Aluminum+Glass	3W	DC 24V	80°	>90	<3%	Lens	Φ 80X115mm

ITEM NO	Material	WATTAGE (w)	Voltage (V)	Angle (°)	CRI	Flicker Free	Optic	SIZE(MM) CXH
LI-Q80	Aluminum+PC	12W	DC 24V	24°	>90	<3%	Lens	Φ 80X148mm

Frosted Glass Ball



Application:
hotels, office, conference room, museums, restaurants, etc.

Option:
Black/White

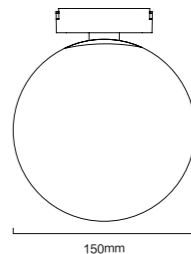

ITEM NO	Material	WATTAGE (w)	Voltage (V)	Angle (°)	CRI	Flicker Free	Optic	SIZE(MM)
LI-BL150	Aluminum+Glass	6W	DC 24V	80°	>90	<3%	Glass	Φ 150mm



ULTRA THIN LIGHT SERIES

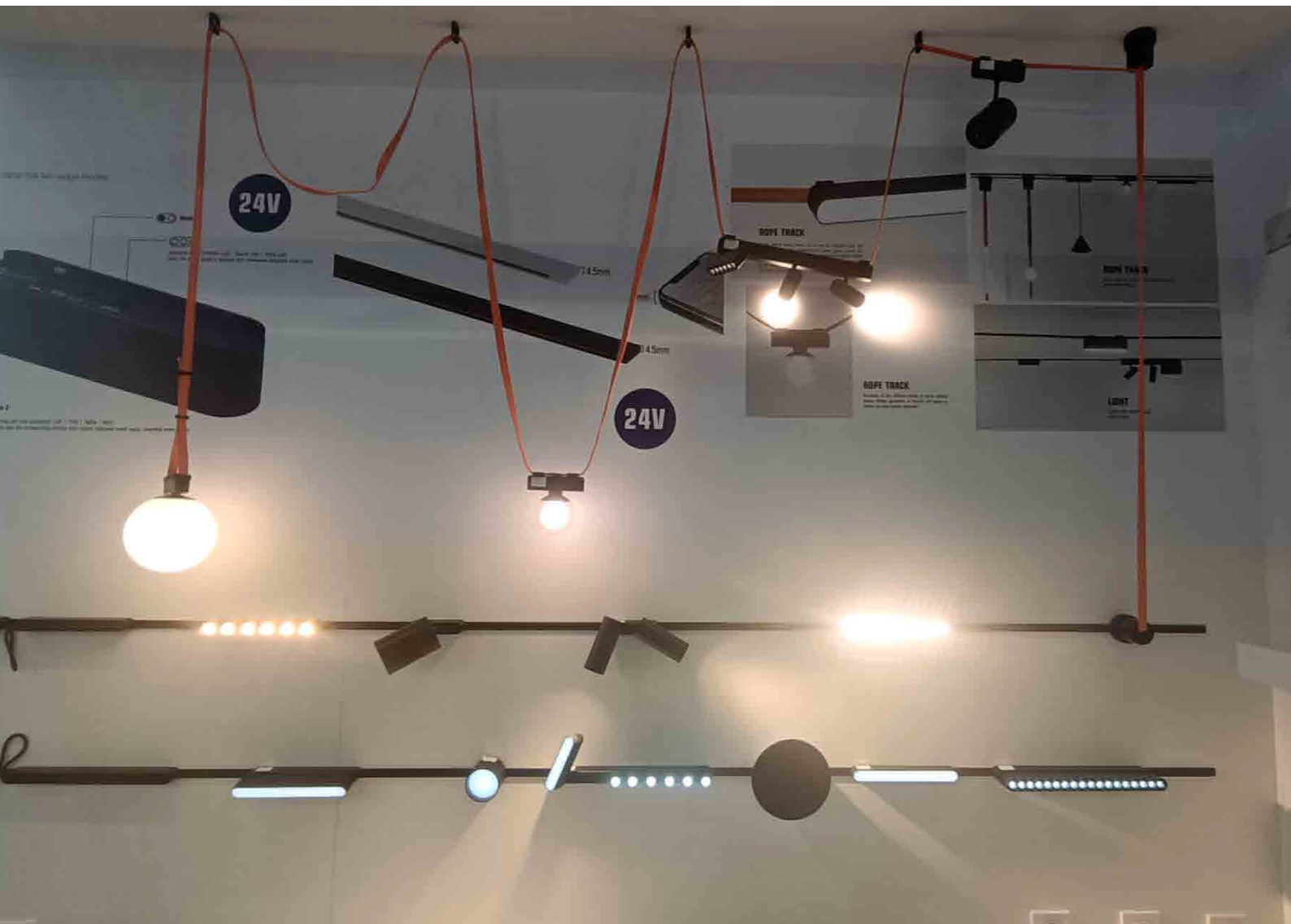

Surface mounted spotlights

Surface Floodlight spotlights



Application:
hotels, office, conference room, museums, restaurants, etc.

Option:
Black/White

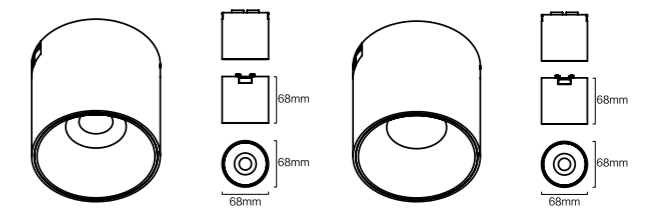

ITEM NO	Material	WATTAGE (w)	Voltage (V)	Angle (°)	CRI	Flicker Free	Optic	SIZE(MM) CXH
LI-TD68	Aluminum+PC	6W	DC 24V	24°	>90	<3%	Lens	φ 68X68mm

ITEM NO	Material	WATTAGE (w)	Voltage (V)	Angle (°)	CRI	Flicker Free	Optic	SIZE(MM) AXBXH
LI-TDF68	Aluminum+PC	6W	DC 24V	60°	>90	<3%	PC Diffusion	φ 68X68mm

ULTRA THIN LIGHT SERIES

Folding light 6 in 1 Floodlight Folding light



Application:
hotels, office, conference room, museums, restaurants, etc.

Option:
Black/White

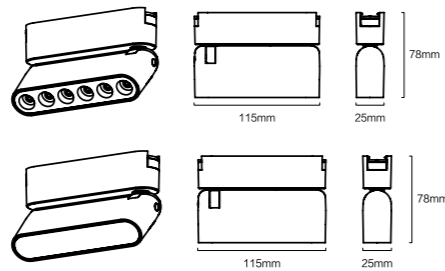

ITEM NO	Material	WATTAGE (w)	Voltage (V)	Angle (°)	CRI	Flicker Free	Optic	SIZE(MM) AXBXH
LI-ZD6	Aluminum+PC	6W	DC 24V	24°	>90	<3%	Lens	115X25X78mm

ITEM NO	Material	WATTAGE (w)	Voltage (V)	Angle (°)	CRI	Flicker Free	Optic	SIZE(MM) AXBXH
LI-ZD6F	Aluminum+PC	6W	DC 24V	110°	>90	<3%	PC Diffusion	115X25X78mm

Folding light 12 in 1 Floodlight Folding light

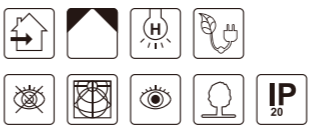

Application:
hotels, office, conference room, museums, restaurants, etc.

Option:
Black/White

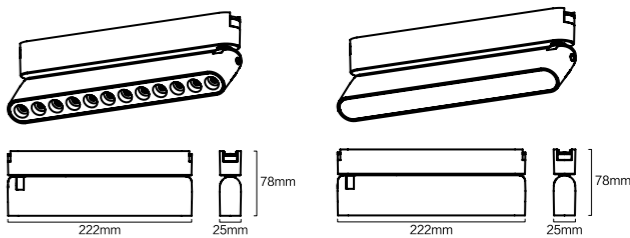

ITEM NO	Material	WATTAGE (w)	Voltage (V)	Angle (°)	CRI	Flicker Free	Optic	SIZE(MM) AXBXH
LI-ZD12	Aluminum+PC	12W	DC 24V	24°	>90	<3%	Lens	222X25X78mm

ITEM NO	Material	WATTAGE (w)	Voltage (V)	Angle (°)	CRI	Flicker Free	Optic	SIZE(MM) AXBXH
LI-ZD12F	Aluminum+PC	12W	DC 24V	110°	>90	<3%	PC Diffusion	222X25X78mm



ULTRA THIN LIGHT SERIES

Folding light 18 in 1

Floodlight Folding light

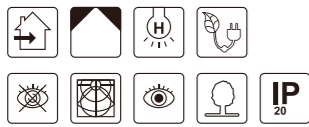

Application:
hotels, office, conference room, museums, restaurants, etc.

Option:
Black/White

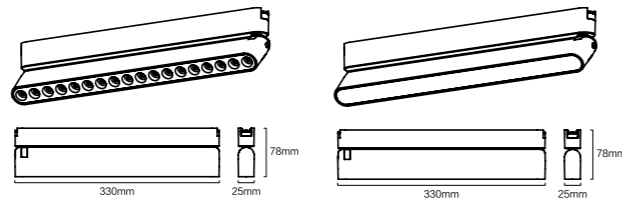

ITEM NO	Material	WATTAGE (w)	Voltage (V)	Angle (°)	CRI	Flicker Free	Optic	SIZE(MM) AXBXH
LI-ZD18	Aluminum+PC	18W	DC 24V	24°	>90	<3%	Lens	330X25X78mm

ITEM NO	Material	WATTAGE (w)	Voltage (V)	Angle (°)	CRI	Flicker Free	Optic	SIZE(MM) AXBXH
LI-ZD18F	Aluminum+PC	18W	DC 24V	110°	>90	<3%	PC diffusion	330X25X78mm

Folding light LEGO series

Folding light LEGO series

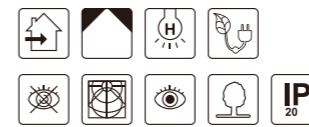
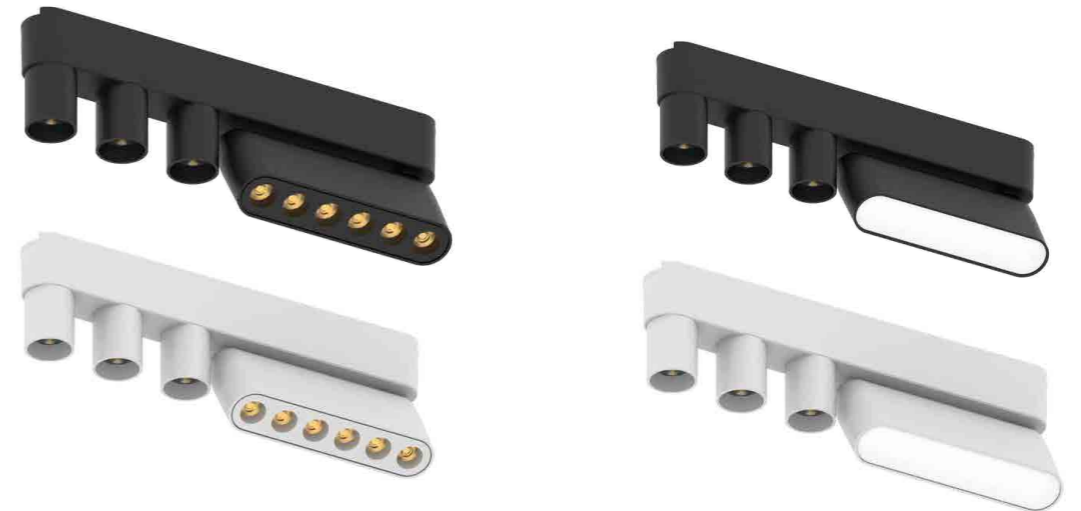

Application:
hotels, office, conference room, museums, restaurants, etc.

Option:
Black/White

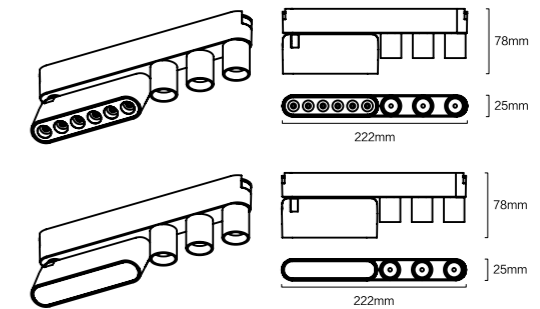

ITEM NO	Material	WATTAGE (w)	Voltage (V)	Angle (°)	CRI	Flicker Free	Optic	SIZE(MM) AXBXH
LI-ZD6T-3TM	Aluminum+PC	6W+3W	DC 24V	24°	>90	<3%	Lens	222X25X78mm

ITEM NO	Material	WATTAGE (w)	Voltage (V)	Angle (°)	CRI	Flicker Free	Optic	SIZE(MM) AXBXH
LI-ZD6F-3TM	Aluminum+PC	6W+3W	DC 24V	110°+24°	>90	<3%	PC diffusion+Lens	222X25X78mm

ULTRA THIN LIGHT SERIES

Folding light LEGO series

Folding light LEGO series



Application:
hotels, office, conference room, museums, restaurants, etc.

Option:
Black/White

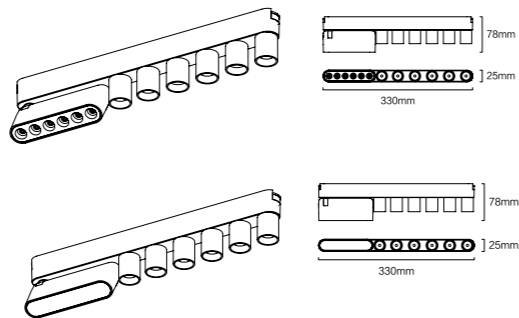

ITEM NO	Material	WATTAGE (w)	Voltage (V)	Angle (°)	CRI	Flicker Free	Optic	SIZE(MM) AXBXH
LI-ZD6T-6TM	Aluminum+PC	6W+6W	DC 24V	24°	>90	<3%	Lens	330X25X78mm

ITEM NO	Material	WATTAGE (w)	Voltage (V)	Angle (°)	CRI	Flicker Free	Optic	SIZE(MM) AXBXH
LI-ZD6F-6TM	Aluminum+PC	6W+6W	DC 24V	110°+24°	>90	<3%	PC diffusion+Lens	330X25X78mm

Deep anti glare grille light 3 in 1

Deep anti glare grille light 6 in 1

Deep anti glare grille light 9 in 1



Application:
hotels, office, conference room, museums, restaurants, etc.

Option:
Black/White

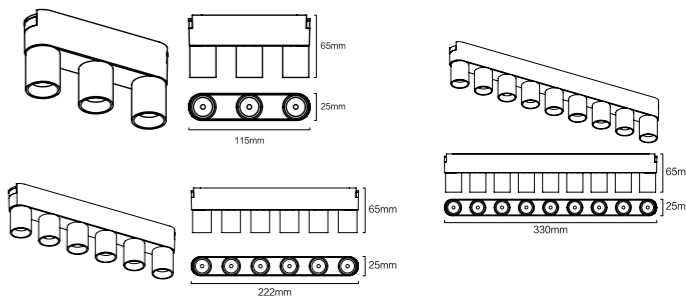

ITEM NO	Material	WATTAGE (w)	Voltage (V)	Angle (°)	CRI	Flicker Free	Optic	SIZE(MM) AXBXH
LI-3TM	Aluminum+PC	3W	DC 24V	24°	>90	<3%	Lens	115X25X65mm

ITEM NO	Material	WATTAGE (w)	Voltage (V)	Angle (°)	CRI	Flicker Free	Optic	SIZE(MM) AXBXH
LI-6TM	Aluminum+PC	6W	DC 24V	24°	>90	<3%	Lens	222X25X65mm

ITEM NO	Material	WATTAGE (w)	Voltage (V)	Angle (°)	CRI	Flicker Free	Optic	SIZE(MM) AXBXH
LI-9TM	Aluminum+PC	9W	DC 24V	24°	>90	<3%	Lens	330X25X65mm



24V

4.5mm Thickness
16.5mm Width



24V ULTRA THIN
LINEAR TRACK

Thin as cicada wings



Folding light LEGO series

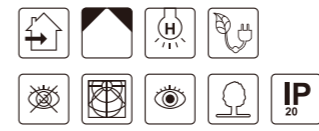

Application:
hotels, office, conference room, museums, restaurants, etc.

Option:
Black/White

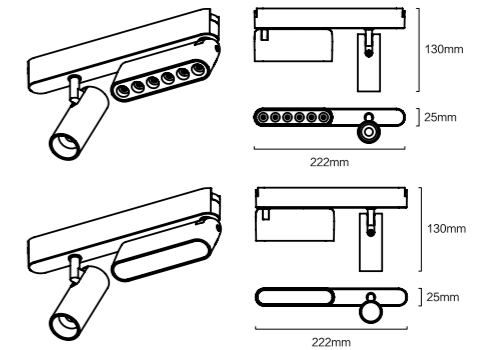

ITEM NO	Material	WATTAGE (w)	Voltage (V)	Angle (°)	CRI	Flicker Free	Optic	SIZE(MM) AXBXH
LI-ZD6T-L33	Aluminum+PC	6Wx2	DC 24V	24°	>90	<3%	Lens	222X25X130mm

ITEM NO	Material	WATTAGE (w)	Voltage (V)	Angle (°)	CRI	Flicker Free	Optic	SIZE(MM) AXBXH
LI-ZD6F-L33	Aluminum+PC	6Wx2	DC 24V	110°+24°	>90	<3%	PC diffusion+Lens	222X25X130mm



ULTRA THIN LIGHT SERIES

Folding light LEGO series

Folding light LEGO series

Cone shaped chandelier



Application:
hotels, office, conference room, museums, restaurants, etc.

Option:
Black/White

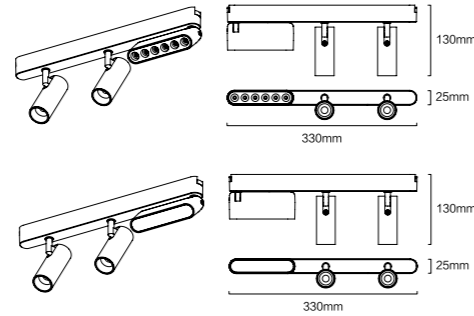

ITEM NO	Material	WATTAGE (w)	Voltage (V)	Angle (°)	CRI	Flicker Free	Optic	SIZE(MM) AXBXH
LI-ZD6T-L33*2	Aluminum+PC	6Wx3	DC 24V	24°	>90	<3%	Lens	330X25X130mm

ITEM NO	Material	WATTAGE (w)	Voltage (V)	Angle (°)	CRI	Flicker Free	Optic	SIZE(MM) AXBXH
LI-ZD6F-L33*2	Aluminum+PC	6Wx3	DC 24V	110°+24°x2	>90	<3%	PC diffusion+Lens	330X25X130mm

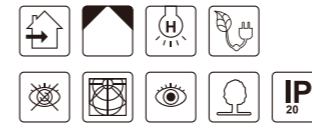

Application:
hotels, office, conference room, museums, restaurants, etc.

Option:
Black/White

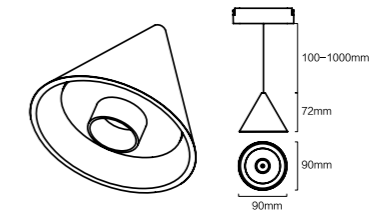

ITEM NO	Material	WATTAGE (w)	Voltage (V)	Angle (°)	CRI	Flicker Free	Optic	SIZE(MM) CXH
LI-MD90	Aluminum+PC	6W	DC 24V	24°	>90	<3%	Lens	Φ90X72mm

ULTRA THIN LIGHT SERIES

Silicone light tube 1M

Silicone light tube 2M

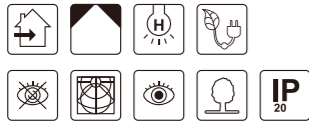
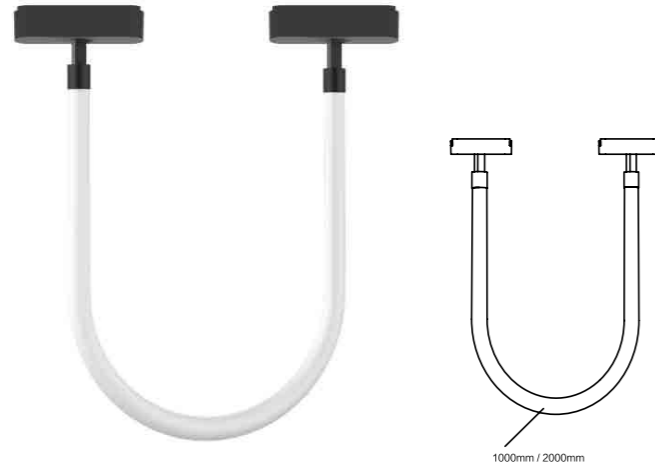

Application:
hotels, office, conference room, museums, restaurants, etc.

Option:
Black/White

ITEM NO	Material	WATTAGE (w)	Voltage (V)	Angle (°)	CRI	Flicker Free	Optic	SIZE(MM) CXH
LI-RG1000	Aluminum+PC	14W	DC 24V	360°	>90	<3%	Silica Gel	Φ22X1000mm

ITEM NO	Material	WATTAGE (w)	Voltage (V)	Angle (°)	CRI	Flicker Free	Optic	SIZE(MM) CXH
LI-RG2000	Aluminum+PC	28W	DC 24V	360°	>90	<3%	Silica Gel	Φ22X2000mm

Track Bluetooth Audio

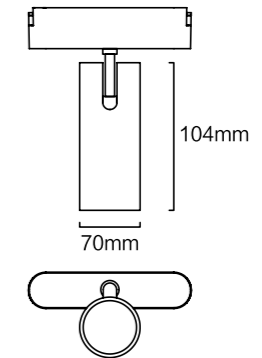

Bluetooth audio is divided into host and auxiliary machine, only need to connect the host, the other auxiliary machine will be automatically connected.



Application:
hotels, office, conference room, museums, restaurants, etc.

Bluetooth version:
V5.3

Bluetooth distance:
10 meters barrier-free

Transmit power:
12DB

Main and secondary broadcast distance:
15-20 meters barrier-free

Option:
Black/White

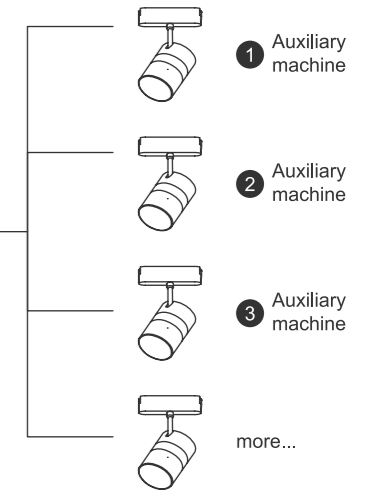
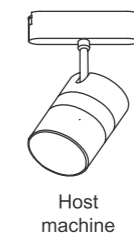
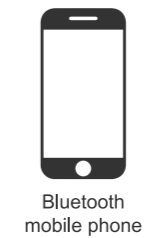

ITEM NO	Material	WATTAGE (w)	Voltage (V)	Angle (°)	SIZE(MM) CXH
LI-AUDIO	Aluminum+PC	10W	DC 24V	360°	Φ70X104mm

ULTRA THIN LIGHT SERIES

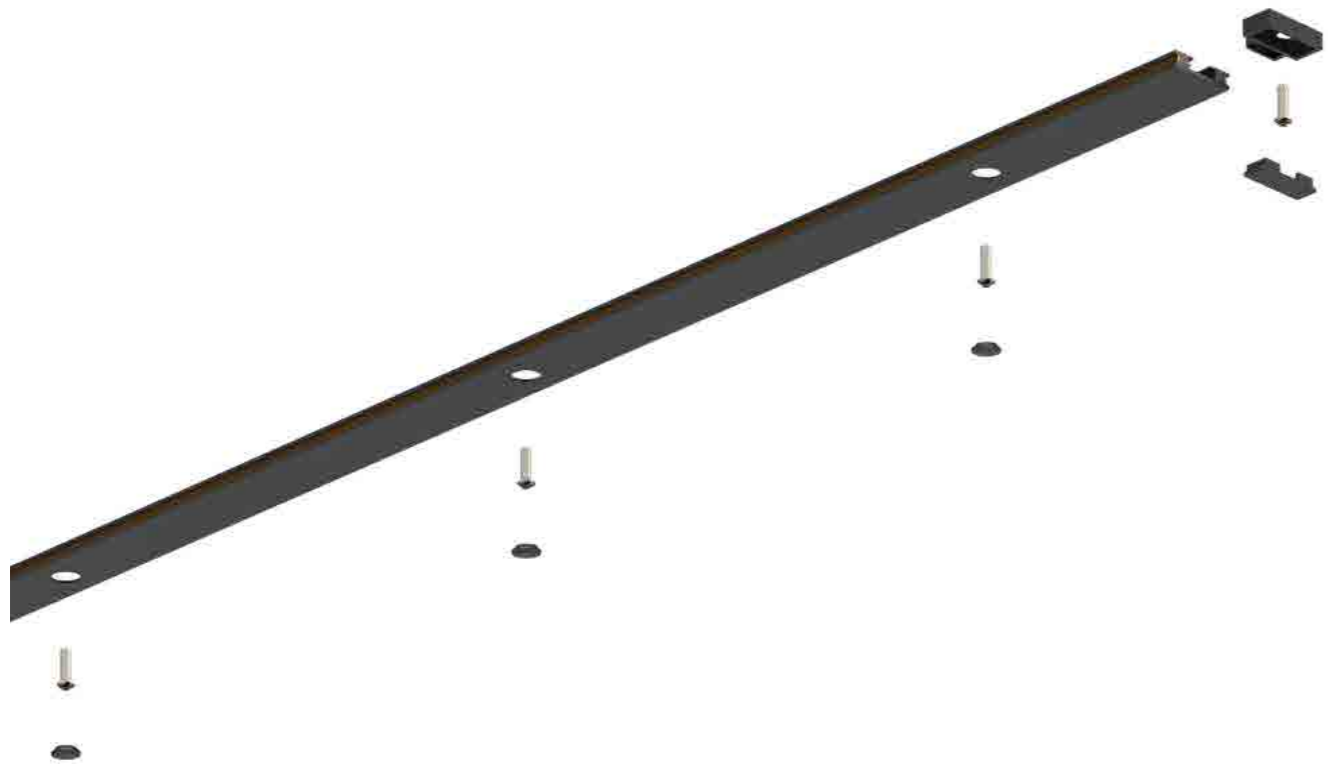

24V ULTRA THIN LINEAR TRACK

The Linear Track is mini size 16x4.5mm

 Track can be cut arbitrarily

 The Lamp have safety locks

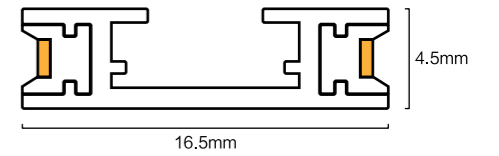

24V ULTRA THIN LINEAR TRACK

ITEM NO	Material	WATTAGE (w)	Voltage (V)	SIZE(MM) AXBXH
LI-1M	Aluminum+Copper	200W(Max)	DC 24V	1000x16.5x4.5mm
LI-1.5M	Aluminum+Copper	200W(Max)	DC 24V	1500x16.5x4.5mm
LI-2M	Aluminum+Copper	200W(Max)	DC 24V	2000x16.5x4.5mm
LI-3M	Aluminum+Copper	200W(Max)	DC 24V	3000x16.5x4.5mm

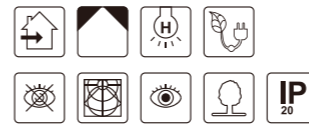

Application:
hotels, office, conference room, museums, restaurants, etc.

Option:
Black/White

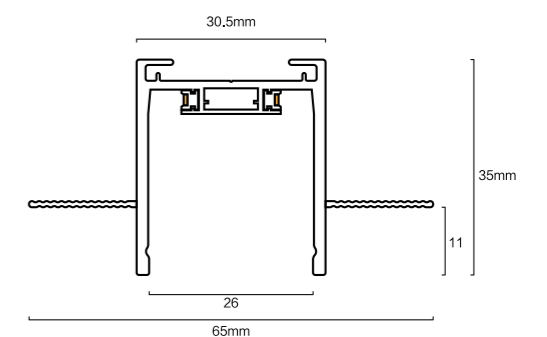
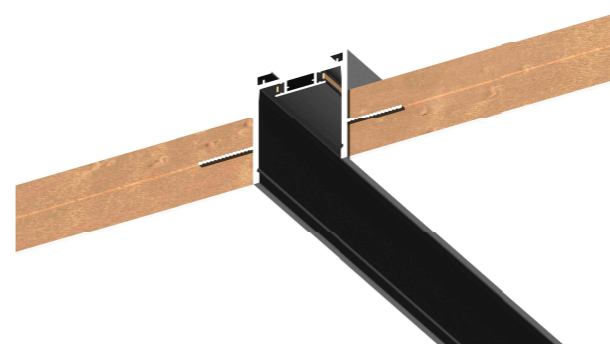

24V CONCEALED LINEAR TRACK

ITEM NO	Material	WATTAGE (w)	Voltage (V)	SIZE(MM) AXBXH
LI-D-1M	Aluminum+Copper	200W(Max)	DC 24V	1000x65x35mm
LI-D-1.5M	Aluminum+Copper	200W(Max)	DC 24V	1500x65x35mm
LI-D-2M	Aluminum+Copper	200W(Max)	DC 24V	2000x65x35mm
LI-D-3M	Aluminum+Copper	200W(Max)	DC 24V	3000x65x35mm



Application:
hotels, office, conference room, museums, restaurants, etc.

Option:
Black/White



ULTRA THIN LIGHT SERIES



**SEAMLESS STITCHING
EASY INSTALLATION**



Straight connect module
ITEM NO: LI-I
Product Size: 36.5x16.5x4.5mm



T connect module
ITEM NO: LI-T
Product Size: 36.5x26.5x4.5mm



L connect module
ITEM NO: LI-L
Product Size: 26.5x26.5x4.5mm



Cross connect module
ITEM NO: LI-+
Product Size: 36.5x36.5x4.5mm



In&Out connect module
ITEM NO: LI-LV
Product Size: 21.5x21.5x4.5mm

- Watt: 200W(Max)
 - Voltage: DC 24V
 - Color: Black/White
 - Material: Aluminum+Copper
-



DC 24V

Color: Black/White
Material: ALUMINU+PC
Function: conventional switching power supply/intelligent centralized switching power supply



100w power supply
ITEM NO: LI-100W
Product Size: 222x25x29mm

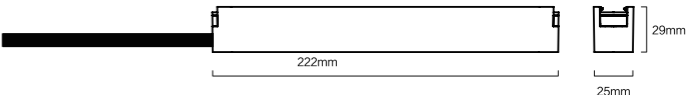

200w power supply/ Integrated power supply100W
ITEM NO: LI-200W/100W-2.4G/100W-TUYA
Product Size: 330x25x29mm

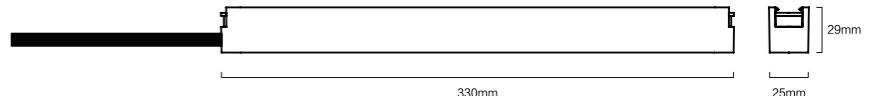

Cable Box
ITEM NO: LI-CXH
Product Size: 100x25x29mm

-

ULTRA THIN LIGHT SERIES

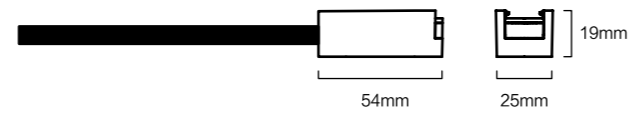
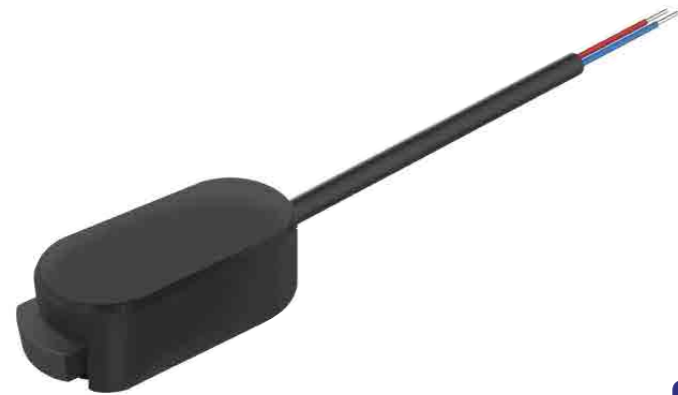

INPUT MODULE

Product Code: LI-SRMK
Product Size: 54x25x19mm

The track bar is energized by connecting the input module with an external transformer

The track bar is energized by connecting the input module with an external transformer

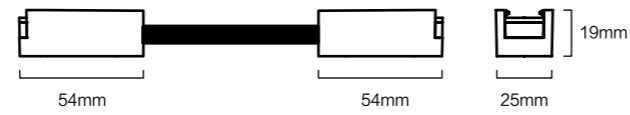
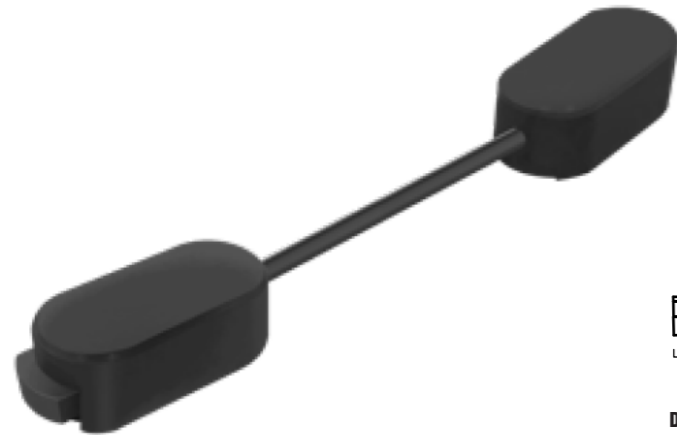

DIRECT POWER MODULE/ANGLE POWER MODULE

Product Code: LI-ZJ/LI-RJ
Product Size: 54x25x19mm*2

The power module is used to energize the rails when they are joined

The power module is used to energize the rails when they are joined

